



The Agilent 7890A Gas Chromatograph

All the elements for perfect chemistry.

Our measure is your success.

Introducing the Agilent 7890A Gas Chromatograph.

Step up to a higher level of GC reliability, productivity and confidence.

Adding an exciting new chapter to a 40-year history of GC leadership, Agilent's new 7890A flagship GC gives you everything you need to take your lab to the next level of GC and GC/MS performance, including advanced separation capabilities, powerful new productivity features and real-time self-monitoring instrument intelligence. Plus, of course, legendary Agilent reliability.



The new Agilent 7890A Gas Chromatograph brings important new separation capabilities and productivity features to the industry-leading Agilent GC platform.

Agilent Performance and Reliability

5th-generation electronic pneumatics control (EPC) and digital electronics set a new benchmark for retention time locking (RTL) precision and help make the 7890A Agilent's most dependable GC ever.

Higher Productivity

Faster oven cool down, robust backflush capability, advanced automation features and faster GC/MS oven ramps let you get more done in less time, at the lowest possible cost per sample—all easily incorporated into your existing method.

Expanded Chromatographic Capabilities

Highly flexible EPC design enables even more sophisticated hydrocarbon analyses. An optional 3rd detector (TCD) can speed up complex gas analyses and allows more types of analyses to be run on a single GC.

Easier Operation

Powerful, chromatographer-friendly software simplifies method setup and system operation and minimizes training time. Practical, time-saving design features speed up and simplify routine maintenance.

Easy, direct method transfer from your 6890 GC

Because the Agilent 7890A system is built upon proven 6890 GC inlets, detectors and GC oven, you can transfer methods to the 7890A GC with complete confidence. We make it even easier with Agilent ChemStation software that can automate the process.



Breakthrough Capillary Flow Technology.

Agilent's innovative Capillary Flow modules enable reliable, leak-free in-oven connections. Available in a number of useful configurations, they are versatile tools for analyzing complex matrices, as well as providing gains in productivity and data integrity. **Page 6**



Perform inlet maintenance in seconds!

Convenient new Turn-Top design is built into each split/splitless (SSL) inlet, allowing you to change liners more quickly and easily than ever before, without special tools or training.

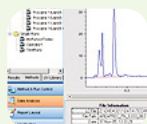

Customized control and data-handling software.

Choose the software package that exactly meets your lab's needs—from single user/single instrument to multi-instrument/multi-vendor laboratories throughout the world. **Page 10**



Agilent LTM Technology accelerates analytical cycle times.

Agilent Low Thermal Mass (LTM) technology provides direct rapid heating and cooling of capillary columns for extremely fast analytical cycle times and higher productivity. **Page 11**



New Multimode inlet serves as two inlets in one.

Agilent's Multimode inlet (MMI) includes split/splitless, temperature ramping and large volume injection capabilities. **Page 12**



Complete selection of options and accessories.

Configure the exact system to meet your lab's needs today and easily adapt to changing application and throughput requirements. **Page 12**



One-button access for service, maintenance and logs.

The Agilent 7890A GC's control panel—which will be instantly familiar to 6890 GC users—includes a new button that gives you instant access to routine maintenance information.

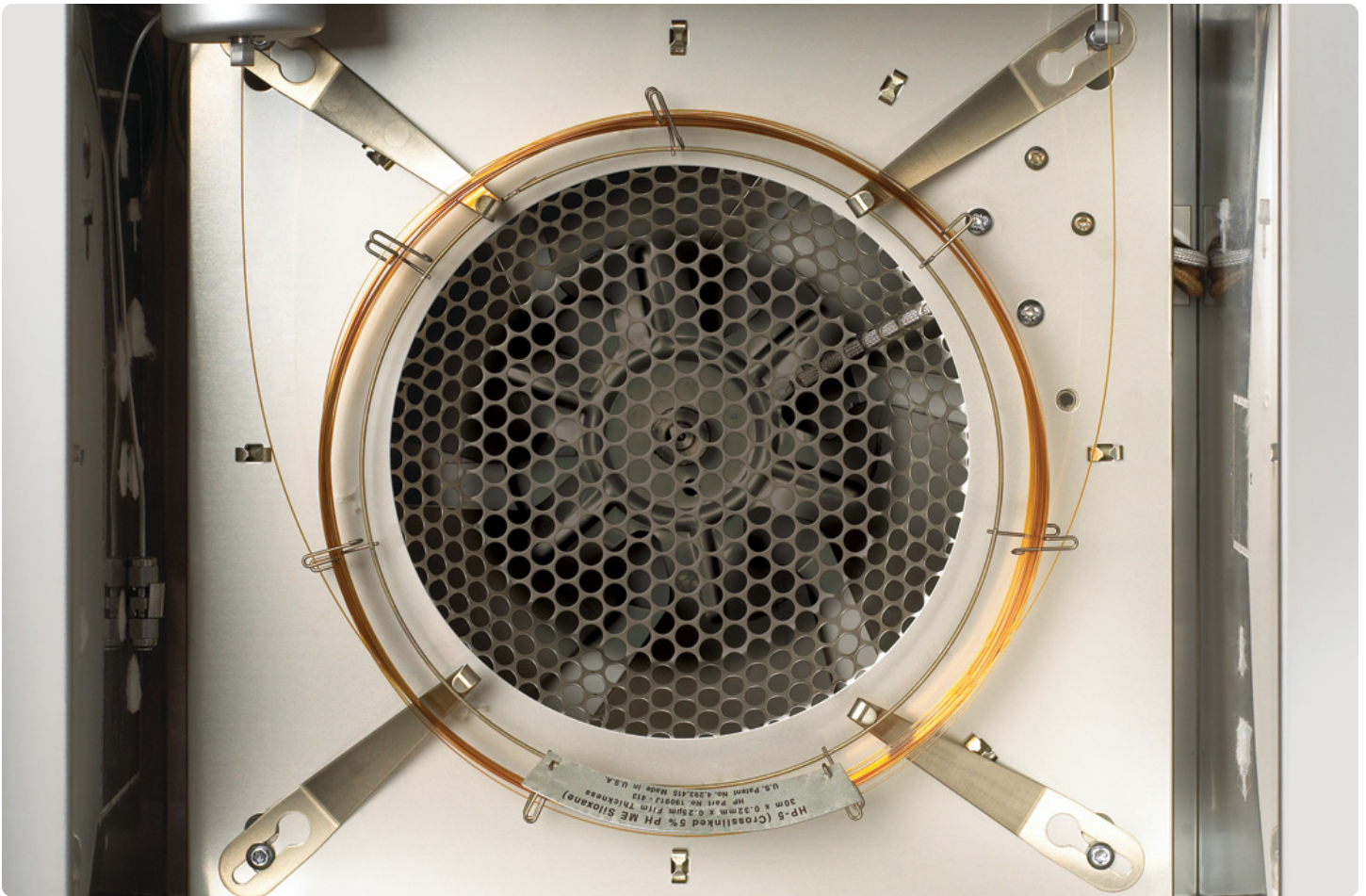

The heart of performance.

The combination of precise pneumatics, GC column oven temperature control, and Agilent J&W GC columns leads to outstanding retention time repeatability, the basis for all chromatographic measurement.

**At the end of the day,
it's about getting a job done.**

At Agilent, building the world's most trusted GC solutions is an ongoing process of evolution. Each new generation of instruments offers improved performance, higher productivity, greater precision and new analytical capabilities. It's easy to get excited about technology and we do. But we never lose sight of the fact that no matter what the application, the bottom line is results: Getting better data with greater confidence and processing more samples in less time at the lowest possible cost.



The heart of reliability.

Integrated electronics and advanced mechanical design provide for superior reliability. The pneumatics manifold of the 7890A has been re-engineered for even greater reliability.

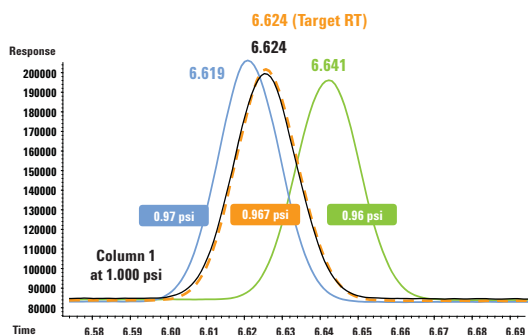

5th-generation EPC and advanced digital electronics set a new benchmark in pressure setpoint precision (to 0.001 psi)—improving RTL precision for very-low-pressure applications.

Retention Time Locking—now even more precise

Agilent's unique retention time locking (RTL) software enables you to reproduce retention times with extreme precision from one Agilent GC system to another—regardless of inlet, detector, operator or location. This powerful software capability allows you to identify peaks more easily and accurately and increase sample throughput, as well as reducing the risk of noncompliance.

Unsurpassed Retention Time Reproducibility

Run	Peak 1*	Peak 2*
1	9.0839 min	11.8492 min
2	9.0835	11.8492
3	9.0841	11.8494
4	9.0846	11.8496
5	9.0851	11.8507
6	9.0849	11.8502
7	9.0845	11.8504
8	9.0849	11.8500
9	9.0847	11.8504
10	9.0853	11.8502
11	9.0852	11.8502
12	9.0851	11.8508
13	9.0847	11.8503
14	9.0848	11.8507
15	9.0853	11.8506
Average	9.0847 min	11.8501 min
Standard Deviation	0.000527	0.000535

*Heart-cut from column 1

Full electronic pneumatics control makes it fast and easy to set all pressures and flows. Our 5th-generation EPC and digital electronics keep these setpoints constant from run to run, providing superior retention time repeatability.

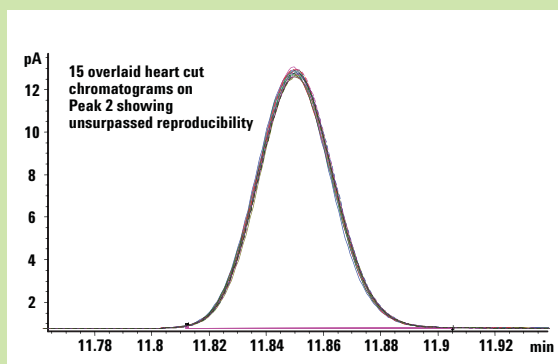

Not only is one ensured unsurpassed retention time reproducibility in standard applications but also in multi-dimensional applications such as the heart-cutting example shown here.

Add extra dimensions to your chromatography with Agilent Capillary Flow Technology.

Agilent's proprietary Capillary Flow Technology solves a problem chromatographers have been wrestling with for decades: How to make reliable, leak-free capillary connections that can stand up to the temperature extremes of a modern GC oven.

These inert, low-mass, low-dead volume devices not only make it easy to make secure connections, they give you the ability to precisely divert your gas flow pneumatically, where and when you want. This opens the door to highly useful techniques that can improve your analytical results, as well as saving time and resources. For example:

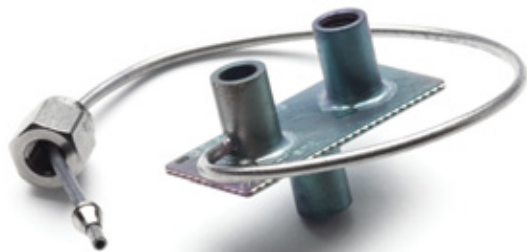

QuickSwap

Here's an elegant answer to a common GC/MS problem: Waiting around for a mass spectrometer to vent before you can change out a column or perform routine inlet maintenance.

Using a simple, inexpensive "QuickSwap" device, you can safely disconnect the column without venting and without losing vacuum—in about 30 seconds! (1)

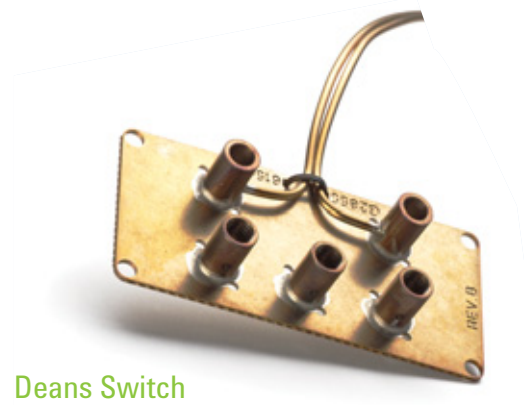

Deans Switch

The idea of fluidic switching between two columns, or redirecting effluent, has been around almost since the beginning of GC. But before Capillary Flow Technology, the implementation hasn't been reliable enough for routine use in a GC oven.

Deans switching enables two-dimensional GC ("heart-cutting") for analysis of trace compounds in complex samples. Flow redirection can also reduce maintenance costs by protecting detectors or columns. (2)

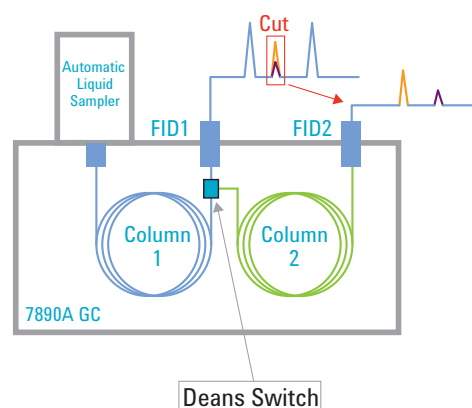

In this example, the Capillary Flow Deans Switch provides additional selectivity that enables the analysis of unresolved trace components by heart-cutting onto another column having a different stationary phase.

(1) 5989-9803EN: Cut Maintenance Time from Hours to Minutes—Capillary Flow Technology QuickSwap

(2) 5989-9384EN: Increase the Resolving Power of Your GC—Capillary Flow Technology Deans Switch

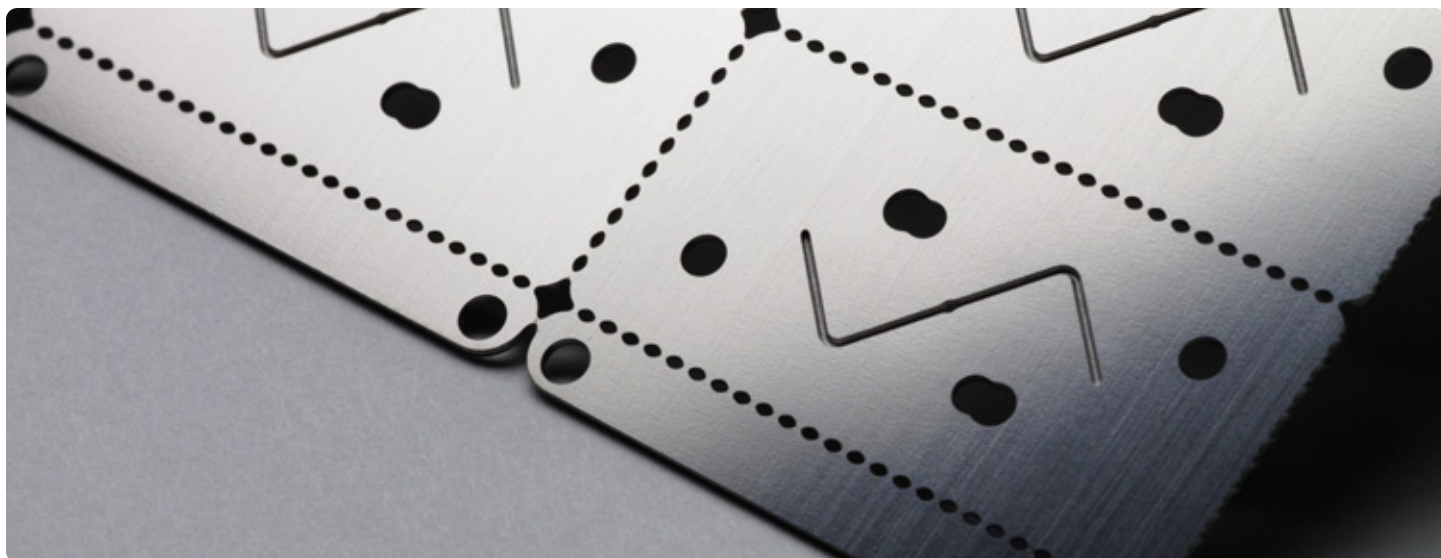

The heart of Capillary Flow Technology.

Photolithographic chemical milling of diffusion-bonded plates provides flow channels with low dead volumes. Low thermal mass ensures reliable tracking of GC oven temperatures.

Flow Splitting

Flow splitting—sending the sample to multiple detectors—can provide the most information from a sample in a single run and is especially valuable for analyzing compounds in complex matrices. This technique can help you locate peaks of interest faster, get better integration of target peaks and have higher overall confidence in identifying unknowns. (3)

Strawberry Extract Highlighting Unknowns

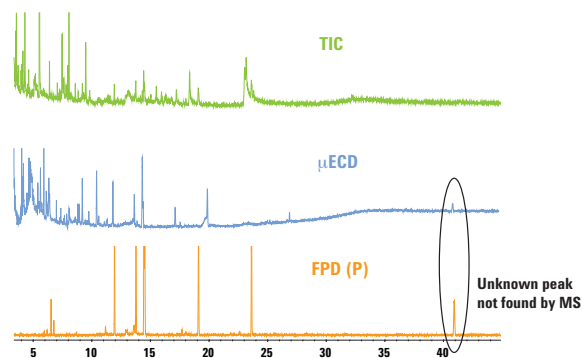

Backflushing

Backflushing is an extremely valuable technique that can be implemented with any purged Agilent Capillary Flow device. It can improve the quality of your analysis and save you time and money on every run—and as backflush occurs post-run, you don't have to change method conditions for the time during the chromatographic run.

By reversing column flow immediately after the last compound of interest has eluted, you can eliminate long bake-out times for highly retained sample components. Instead, these materials are swept backwards through the column and out the split vent, preventing carryover, contamination, retention time shifts and MSD source contamination. (4)

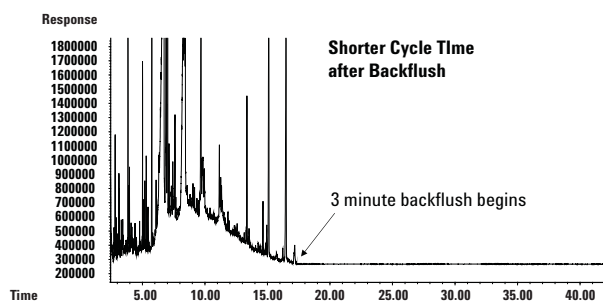
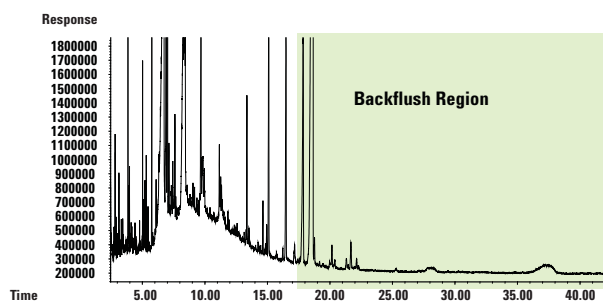

(3) 5989-9667EN: Get More Information in Less Time—Capillary Flow Technology Splitters

(4) 5989-9804EN: Reduce Run Time and Increase Productivity—Capillary Flow Technology Backflush

Advanced separation capabilities save time and enhance results.

EPA 8270

5 ppm EPA 8270 standard run spiked into 5000 ppm of a heavy oil to simulate interference from a hazardous waste.

Peaks of interest elute by 16 minutes, but a 24-minute bake-out at 320°C is required to elute heavy components. Using the 7890A system's backflush capability, the sample was rerun with a 4-minute backflush—saving 20 minutes per run (50% total cycle time savings).

ALS Overlap and faster cool down save an additional 4 minutes per cycle.

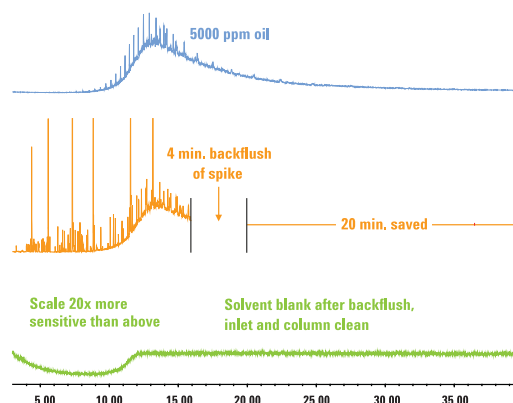

Pesticides in Milk Extract

Flow splitting enables multiple detectors and increased productivity.

The splitter device proportionally splits column effluent to multiple detectors: MSD, DFPD and μ ECD. Full-scan TIC from the MSD provides quantitation and confirmation; element-specific GC signals are useful for highlighting trace-level compounds to be identified by MSD.

The splitter also provides backflush capability to shorten cycle time and increase column life. Backflushing ensures that excess column bleed and heavy residues are not introduced into the MSD, reducing ion source contamination. It also eliminates carryover from sample accumulated at the head of the column, providing a significant improvement in data integrity.

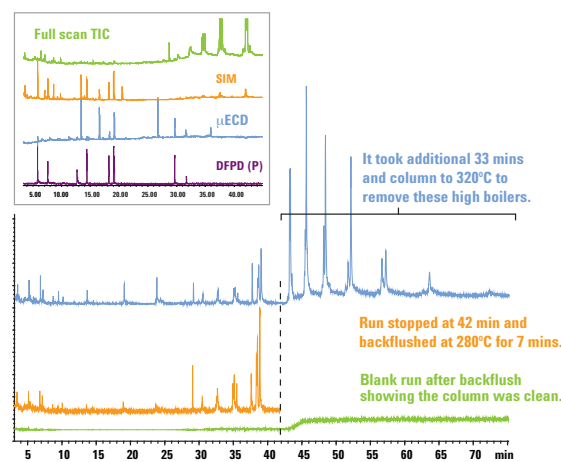

Impurities in Hydrocarbons

Ethylene analysis uses 2D GC to combine measurement by ASTM D6159 with a trace analysis of methanol.

This application takes advantage of Agilent's Capillary Flow Deans Switch device and the new Back Pressure Regulation (BPR) mode of the 7890A GC's Pneumatic Control Module to improve sensitivity and resolution. Dynamic blending systems make multi-level calibrations of gas samples easy and routine.

2-GC Separation of Oxygenates and Hydrocarbon Impurities in Ethylene in a Single Run

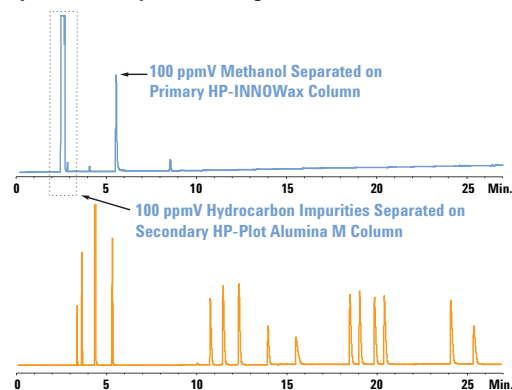

Rapid Drug Screening

Obtaining 3x the information in half the time or less, using GC/NPD/MSD with simultaneous SIM/Scan.

An Agilent Capillary Flow device is used to acquire NPD and MSD data simultaneously. This eliminates the need for a separate NPD screening run on a different GC; backflushing further reduces cycle time. Simultaneous SIM/Scan is used to screen for select low-level drugs, eliminating the need for a separate SIM run.

Overall cycle time is reduced by more than 55%. An existing 6890 GC/MSD method is made twice as fast using a 240V oven. Similar results were also achieved using a 120V oven with the new option for the 7890A high-speed GC/MSD oven. Deconvolution Reporting Software (DRS) further enhances throughput by reducing data interpretation time.

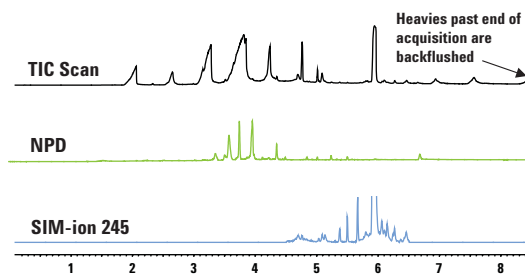

Analysis of Refinery Gases

Faster, high-resolution analysis of complex refinery gas samples using 3 channels of simultaneous detection.

The Agilent 7890A GC now supports an optional 3rd detector (TCD). In this analysis, the GC is configured to run three parallel channels; all three detectors collect data at the same time. Complete analysis time of inert gases and hydrocarbons to n-C6 can be achieved in 6 minutes. (5)

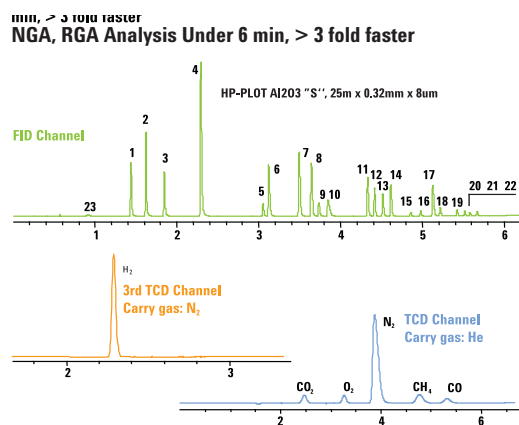

Comprehensive GC Flow Modulation

Capillary Flow Technology enables GC x GC analysis of extremely complex samples—without the need for cryogen.

To date, available GC x GC systems require complicated and costly cryo-focusing techniques. The Agilent 7890A GC uses Capillary Flow Technology to enable flow modulation without the need for cryogen. This analysis of diesel fuel shows the normal boiling point distribution in the first dimension and functional group clusters in the 2nd dimension. (6)

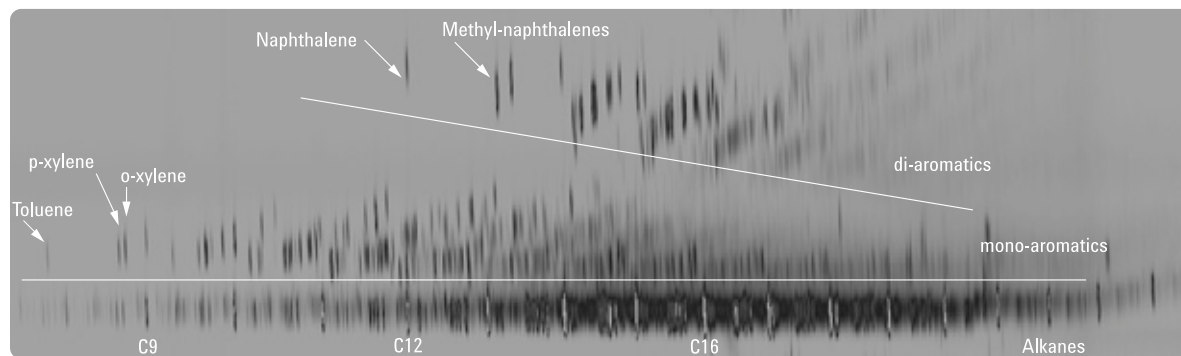

(5) 5989-6103EN: Parallel GC for Complete RGA Analysis

(6) 5989-9889EN: Get a Second Dimension of Information on Complex Samples—Capillary Flow Technology GC x GC Flow Modulator

GC software that fits your workflow and your applications—perfectly.

Agilent GC software makes it easy even for non-expert operators to take advantage of all the advanced capabilities of the new Agilent 7890A system. From the friendly, familiar GC and GC/MSD ChemStation and EZChrom Elite chromatography data systems to our groundbreaking new Lab Advisor Software for real time monitoring of Agilent GC and LC systems in your lab, you'll find everything designed to help you make the most of every run and every workday.

If your 7890A GC will be used in a regulated environment, Agilent software can help there, too, with comprehensive features to address the strict regulatory, certification and quality control requirements of your industry.

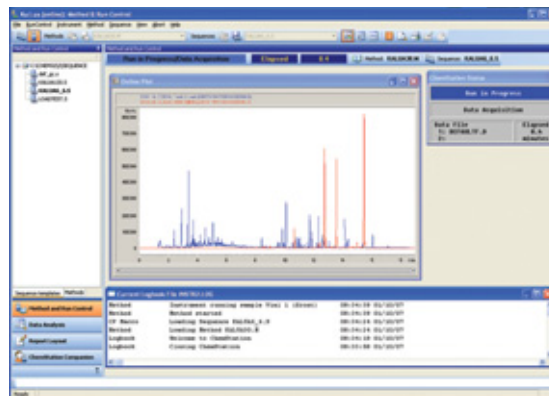

Agilent's industry-leading ChemStation chromatography data system lets you display, calibrate and report data from up to four signals—without having to synchronize separate runs and merge results. This is especially efficient when you need to set up and report complex analyses.

MSD Method Locked to FID Method (Mixture of 25 Pesticides)

Different Detector, Different Location, Different Operator—Same Results.

Retention Time Locking (RTL) software is a powerful productivity tool that lets you reproduce exactly the same results on multiple Agilent GC or GC/MSD systems—configuration to configuration, location to location, operator to operator. This revolutionary Agilent technology allows retention times to be reproduced within hundredths, and even thousandths, of a minute. RTL enables you to more easily and accurately identify peaks, increase sample throughput, reduce the risk of noncompliance, enhance confidence in analytical results—as well as lower your operating costs.

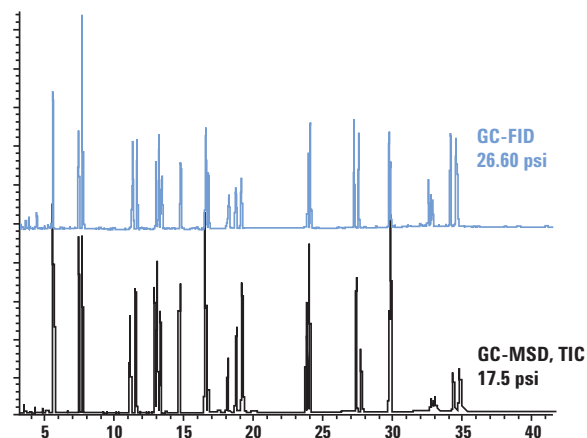

Low Thermal Mass (LTM) technology provides faster analytical cycle times, higher productivity.

Agilent's LTM system for GC and GC/MS provides direct, rapid heating and cooling for faster GC analyses and higher sample throughput. By providing independent temperature control of up to four column modules, the technology opens the door to new capabilities in multi-dimensional GC, and integration with Agilent Capillary Flow Technology can greatly reduce column maintenance. As an added benefit, the LTM system consumes far less power than a conventional GC platform. (7) (8) Our industry-leading Agilent J&W column phases are available as LTM column modules including Wall Coated Open Tubular (WCOT) and Porous Layer Open Tubular (PLOT) columns.

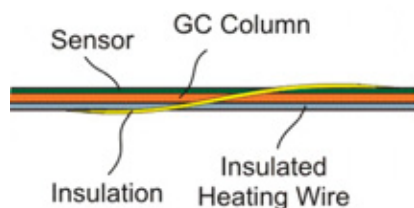

The key to LTM technology: weaving direct heating and temperature sensing components around standard fused-silica capillary column (up to 30 meters) for rapid heating and cooling.

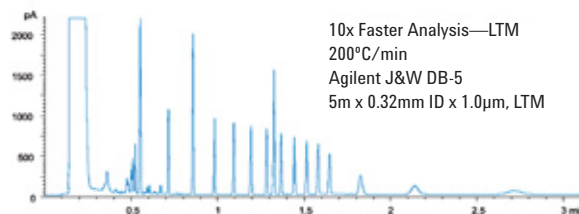

10x Faster Analysis—LTM
200°C/min
Agilent J&W DB-5
5m x 0.32mm ID x 1.0µm, LTM

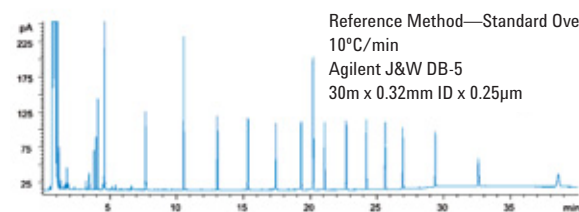

Reference Method—Standard Oven
10°C/min
Agilent J&W DB-5
30m x 0.32mm ID x 0.25µm

LTM vs. conventional GC—Traditional run time for typical alkane standard of 40 minutes is reduced to less than 3 minutes utilizing the LTM system's accelerated ramp rates (200°C/min) and a shorter column. (9)

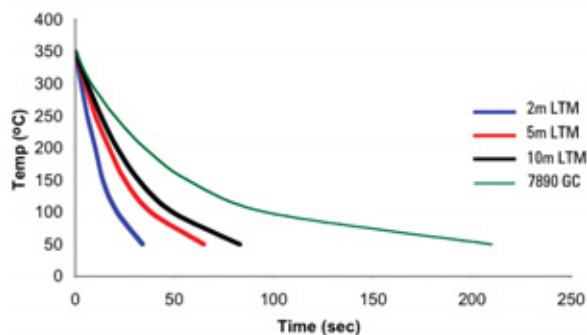

Typical cooling times for standard (5-inch) LTM column modules of typical lengths are significantly faster than a conventional GC oven.

(7) 5990-3325EN: Agilent LTM System for GC and GC/MS. Faster analytical cycle times, higher productivity

(8) 5990-3451EN: Fast Analysis of Polynuclear Aromatic Hydrocarbons Using Agilent Low Thermal Mass (LTM) GC/MS and Capillary Flow Technology QuickSwap for Backflush

(9) 5990-3201EN: Ultra-Fast Total Petroleum Hydrocarbons (TPH) Analysis with Agilent Low Thermal Mass (LTM) GC and Simultaneous Dual-Tower Injection

Ready for anything your lab can throw at it, including the future.

The modular, fully automated Agilent 7890A GC system includes the industry's widest selection of inlets, detectors, columns, consumables and sample introduction choices—in fact, everything you need to keep your lab up and running at peak productivity.

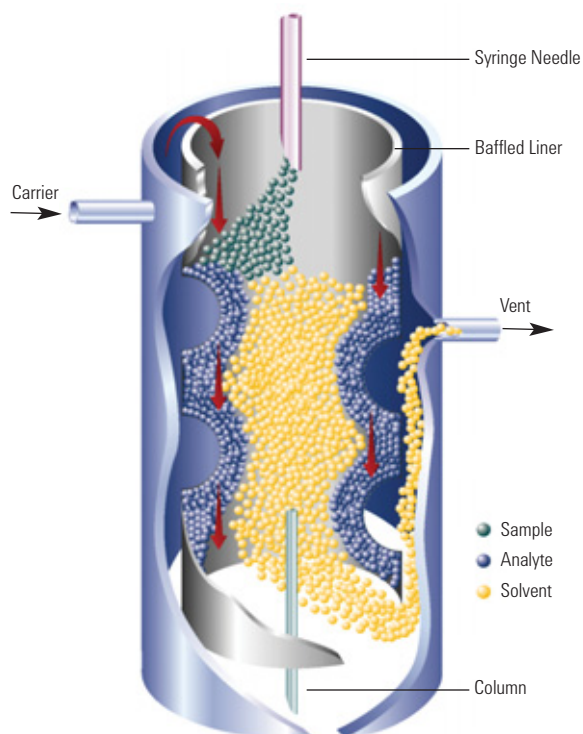

Agilent's highly versatile Multimode inlet (MMI) combines the capabilities of spit/splitless operation (cold, hot and pulsed), temperature programming and large volume injection with a solvent vent mode. Benefits include higher system sensitivity, ability to analyze thermally labile compounds and more robust handling of dirty samples. (10)

Full dynamic range FID

State-of-the-art digital electrometer enables a linear dynamic range of 10^7 , seamlessly integrated into a single run.

Sensitive and selective element detection

Agilent offers a wide variety of element-sensitive detectors, including a Flame Photometric Detector (FPD) that has been recently improved and is 5x more sensitive for sulfur and 10-15x more sensitive for phosphorous. Sulfur Chemiluminescence Detectors (SCD) provide the highest sensitivity and selectivity for demanding applications.



The perfect productivity partner for your Agilent 7890A GC

Add an Agilent 7693 Series Automatic Liquid Sampler for the fastest injection times of any GC autosampler, plus dual simultaneous injection and 150-vial capacity. Enhanced sample preparation capabilities help to eliminate variability and rework and include automated dilution, internal standard addition, heating, mixing and solvent addition. (11)



(10) 5990-3954EN: Agilent Multimode Inlet for Gas Chromatography

(11) 5990-3336EN: Agilent 7693A Series Automatic Liquid Sampler—Inject new performance into your gas chromatography

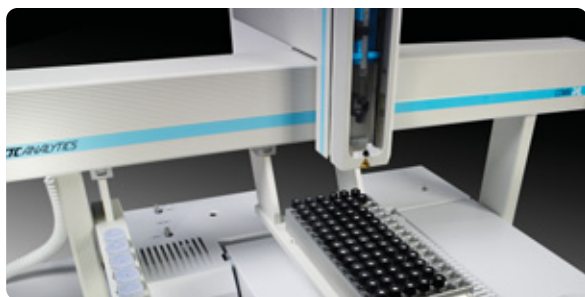

Boost your lab's output with additional sample preparation capabilities

Choose the versatile CombiPAL sample injector for liquid injection, headspace and solid-phase microextraction (SPME). The economical GC PAL platform can be configured for liquid injection only, but offers many of the other capabilities of the CombiPAL including large volume injection (LVI), multiple vial sizes and extended sample vial capacity.



Agilent G1888 Headspace Sampler adds to your analysis capabilities

Automatically introduce volatile compounds from virtually any sample matrix directly into a GC or GC/MS. An inert sample pathway provides superior chemical performance without analyte degradation or loss. Agilent also offers other sample introduction devices for thermal desorption and purge and trap.

High performance Agilent J&W GC columns and supplies to meet every analytical need.

Agilent GC consumables including our Agilent J&W High Efficiency columns, are designed, manufactured and packaged to deliver maximum productivity from your Agilent GC and GC/MSD systems. We strive to provide you with the cleanest, most inert flow path. From our proprietary deactivated inlet liners to our injection-molded inlet gold seal, through the Agilent J&W Ultra Inert GC columns for increased sensitivity, your samples are protected from exposure to active sites or outgassed contaminants that can alter your results.





Widest selection of inlets to optimize your separations

- Split/splitless (SSL) capillary
- Packed purged injection port (PIIP)
- Cool on-column (COC)
- Cool on-column with solvent vapor exit (COC-SVE)
- Programmable temperature vaporizing (PTV)
- Volatiles interface (VI)
- Multimode inlet (MMI)
- High temperature PTV
- High pressure gas sample injection
- Gas Sampling Valve (GSV)
- Liquid Sampling Valve (LSV)

High-sensitivity detectors for every sample type

- 5975 series mass selective detector (MSD)
- 7000A Triple Quadrupole MS
- Flame ionization (FID)
- Thermal conductivity (TCD)
- Micro-electron capture (micro-ECD)
- Flame photometric, single- or dual-wavelength (FPD)
- Nitrogen-phosphorus (NPD)
- Sulfur chemiluminescence (SCD)
- Nitrogen chemiluminescence (NCD)
- Atomic emission (AED)*
- Pulsed flame photometric (PFPD)*
- Photoionization (PID)*
- Electrolytic conductivity (ELCD)*
- Halogen Specific Detector (XSD)*
- Oxygenate Flame Ionization Detector (O-FID)*
- Pulsed Discharge Helium Ionization Detector (PDHID)*

*Available through Agilent Channel Partners
 Contact Agilent for other custom configurations. A wide variety of additional solutions are available via Agilent's channel partners.

Agilent Services keep your lab running at peak productivity.

With a 98% customer satisfaction rating, Agilent's service engineers are the most respected—and best-trained—in the industry. Whether you need support for a single instrument or a multi-lab, multi-vendor operation, we can help you solve problems quickly, increase your uptime and optimize your lab's resources. We offer:

- Expert installation, familiarization and advanced training to get you up and running as quickly as possible
- Comprehensive Agilent Advantage Service plan options for cost-effective maintenance, repair and compliance support
- On-site preventive maintenance that ensures dependable system operation and minimizes unplanned downtime
- Remote monitoring and diagnostics capabilities that help you to maximize instrument uptime and utilization in your lab
- Compliance and functional verification services to support your quality, regulatory, or accreditation initiatives
- Cooperative Support Service plans to provide advanced tools and support for your in-house metrology team

Learn more about Agilent's top-ranked service and support at www.agilent.com/chem/services



7000A Triple Quadrupole MS

Reliable target compound analysis at the lowest limits of detection

The 7000A Triple Quadrupole MS helps you confidently detect and quantify trace-level target analytes in the most complex matrices. Engineered from the ground up for maximum productivity and robust high performance operation, this breakthrough system delivers:

- Routine femtogram-level sensitivity
- Outstanding data acquisition speed
- Superior selectivity of MS/MS
- Ultra-low noise delivered by “helium-quench gas” technology

Agilent's proven acquisition and control interface, along with powerful MassHunter data analysis and reporting software make it easy even for non-expert operators to get expert results, every time.

For more information

Learn more:

www.agilent.com/chem/7890A

Buy online:

www.agilent.com/chem/store

Find an Agilent customer center in your country:

www.agilent.com/chem/contactus

U.S. and Canada

1-800-227-9770

agilent_inquiries@agilent.com

Europe

info_agilent@agilent.com

Asia Pacific

adinquiry_aplsc@agilent.com

Research use only. Information, descriptions and specifications in this publication are subject to change without notice. Agilent Technologies shall not be liable for errors contained herein or for incidental or consequential damages in connection with the furnishing, performance or use of this material.

© Agilent Technologies, Inc. 2009

Printed in USA May 15, 2009

5990-4114EN



Agilent Technologies